



planetary  
行星照明集团

亿智顺™  
Wisdom shun

LED Catalog  
2020



**Planetary Lighting (Shenzhen) Group Co., Ltd.**

Tel: 86-0755-36960879  
hone: 86-13751150321  
E-mail: info@planetarylighing.com  
Website : www.planetarylighting.com  
Address: No. 5, China South City, Pinghu, Longgang District, Shenzhen



Wechat

**Planetary Lighting (Shenzhen) Group Co., Ltd.**

www.planetarylighting.com



LED Lighting  
Manufacturers

Planetary Lighting (Shenzhen) Group Co., Ltd. is located in Shenzhen, Guangdong Province, China, mainly engaged in the production and sales of intelligent lighting. Integrated services, well-known manufacturing companies in the R&D, manufacturing and sales of lighting products, LED lighting, LED panel lights, LED downlights, LED spotlights, LED ceiling lights are mainly suitable for smart home lighting, indoor lighting, Commercial lighting, hotel lighting, the main market in the national and European markets, the company in the 'customer first, Quality-oriented principle, work together for a win-win situation! Official website: [www.yzshun.com](http://www.yzshun.com), [www.wisdomshun.com](http://www.wisdomshun.com), Tel: 0755-36960879 E-mail: [info@yzshun.com](mailto:info@yzshun.com)

## Products Catalogue

LED Bulb light.....	01-04
LED Small Panel light.....	05-06
LED Strips light.....	07- 08
LED Downlight.....	09- 14
LED Panel light .....	15-16
UFO highbay light.....	17- 18
LED Driver.....	19 -20

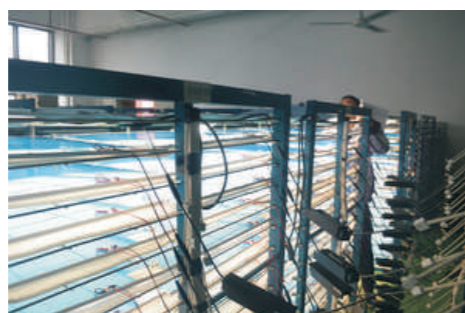

Energy saving \* Safety \* Smart \* Assured \* Durable

YZS-DW-COB-7W

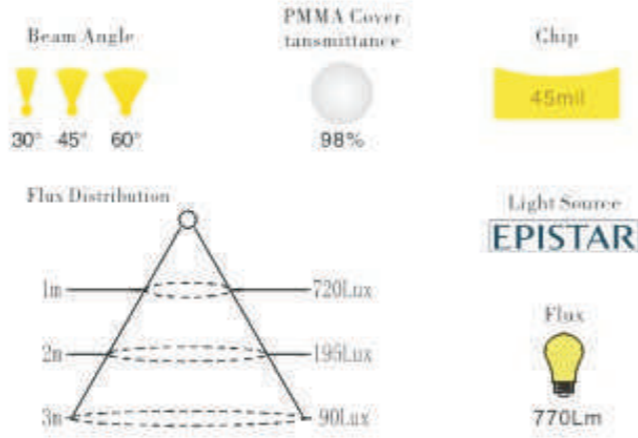
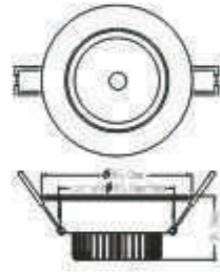

7W

YZS-DW-SMD-3W

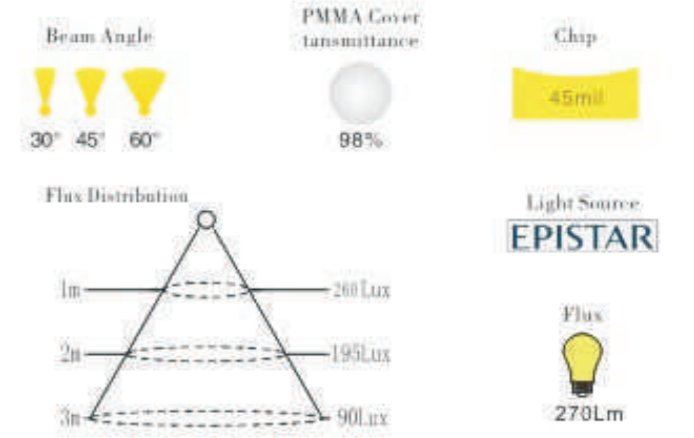
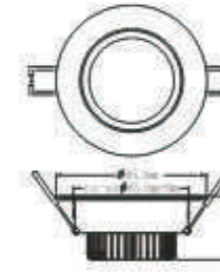

7W

YZS-DW-PZZ-12W

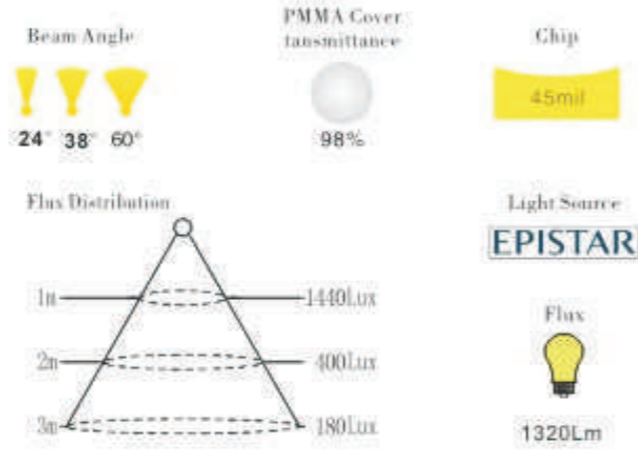
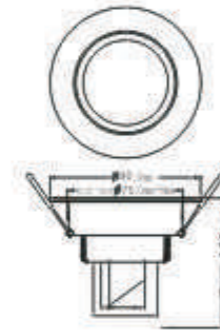

12W

YZS-DW-SH-3W

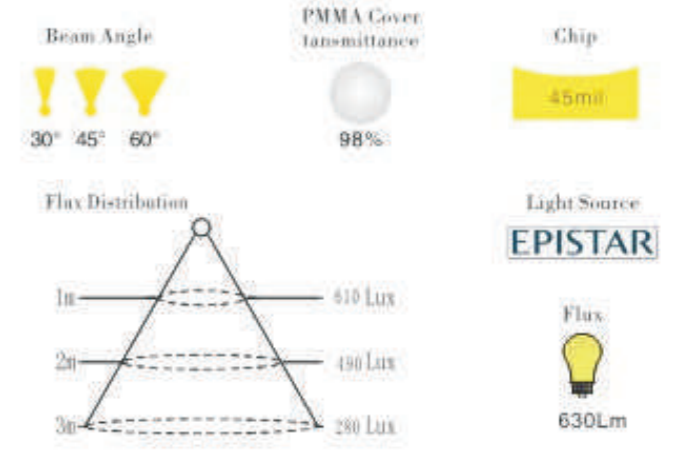

Model No	Power	Voltage	CCT	Flux	Dimension	LED	Beam Angle	Life Span
YZS-DW-COB-7W	7W	AC85V-260V	2700-7500K	770Lm	Φ110*80mm	COB	24°	≥30,000hrs
YZS-DW-COB-12W	12W	AC85V-260V	2700-7500K	1320Lm	Φ110*100mm	COB	24°	≥30,000hrs
YZS-DW-PZZ-12W	12W	AC85V-260V	2700-7500K	1320Lm	Φ95*H108mm	COB	24°	≥30,000hrs
YZS-DW-PZZ-18W	18W	AC85V-260V	2700-7500K	1980Lm	Φ110*H120mm	COB	24°	≥30,000hrs



Model No	Power	Voltage	CCT	Flux	Dimension	LED	Beam Angle	Life Span
YZS-DW-SMD-3W	3W	AC85V-260V	2700-7500K	270Lm	Φ100*45mm	2835	120°	≥30,000hrs
YZS-DW-SMD-7W	7W	AC85V-260V	2700-7500K	630Lm	Φ120*60mm	2835	120°	≥30,000hrs
YZS-GG-SH-3W	3W	AC85V-260V	2700-7500K	270Lm	Φ95*30mm	2835	120°	≥30,000hrs
YZS-GG-SH-7W	7W	AC85V-260V	2700-7500K	630Lm	Φ120*30mm	2835	120°	≥30,000hrs

**YZS-DW-SD-3W**



3W

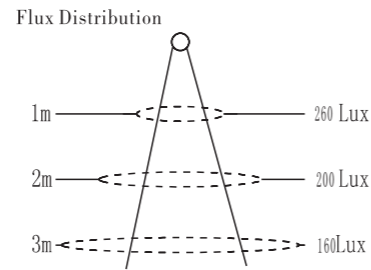
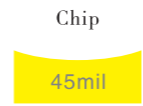
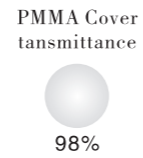
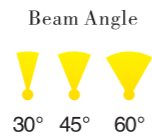
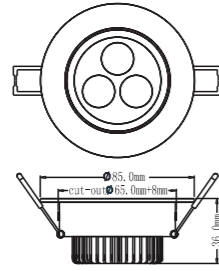

Light Source  
**EPISTAR**



**YZS-DW-SD-6W**



6W

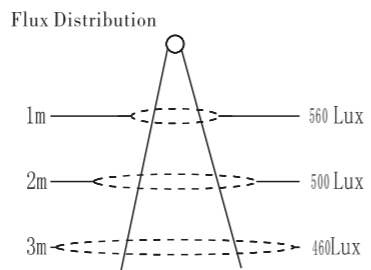
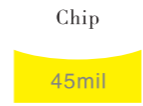
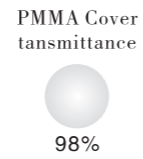
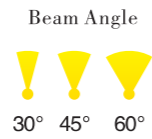
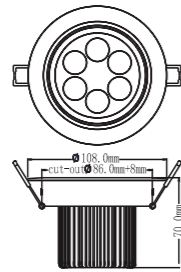

Light Source  
**EPISTAR**



Model No	Power	Voltage	LED	CCT	Flux	Dimension	Beam Angle	Life Span
YZS-DW-SD-3W	3W	AC85V-260V	5050	2700-7500K	300Lm	Φ85x25mm	12°	≥30,000hrs
YZS-DW-SD-6W	6W	AC85V-260V	5050	2700-7500K	600Lm	Φ110x45mm	12°	≥30,000hrs
YZS-DW-SD-9W	9W	AC85V-260V	5050	2700-7500K	900Lm	Φ140x45mm	12°	≥30,000hrs
YZS-DW-SD-12W	12W	AC85V-260V	5050	2700-7500K	1200Lm	Φ140x45mm	12°	≥30,000hrs



**应用场景 Case scenario**





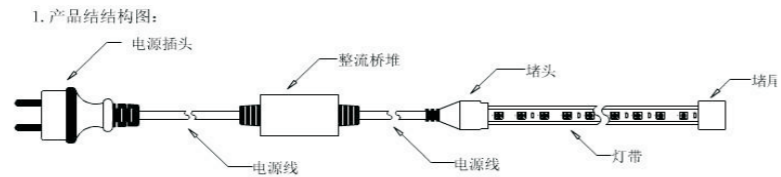

Model No	CCT	Power	Voltage	Light Source	Package	Flux	Beam Angle	Life Span
YZS-ST-AC5730	2700-7500K	6w/m	AC 220V	SMD3014/5730	100meter	70Lm/w	160°	≥30,000hrs
YZS-ST-AC2835	2700-7500K	8w/m	AC 220V	2835	100meter	70Lm/w	160°	≥30,000hrs
YZS-ST-AC5050	2700-7500K	10w/m	AC 220V	5050	100meter	70Lm/w	160°	≥30,000hrs
YZS-ST-ACRGB	RGB	8w/m	AC 220V	5050	100meter	70Lm/w	160°	≥30,000hrs



Model No	CCT	Power	Voltage	Light Source	Package	Flux	Beam Angle	Life Span
YZS-ST-SO5730	2700-7500K	6w/m	AC 220V	SMD3014/5730	100meter	70Lm/w	160°	≥30,000hrs
YZS-ST-SO2835	2700-7500K	8w/m	AC 220V	2835	100meter	70Lm/w	160°	≥30,000hrs
YZS-ST-SO5050	2700-7500K	10w/m	AC 220V	5050	100meter	70Lm/w	160°	≥30,000hrs
YZS-ST-SORGB	RGB	8w/m	AC 220V	5050	100meter	70Lm/w	160°	≥30,000hrs

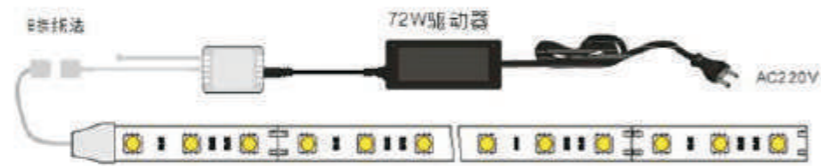

Model No	CCT	Power	Voltage	Light Source	Package	Flux	Beam Angle	Life Span
YZS-ST-DC-IP20	2700-7500K	5w/m	AC 220V	SMD3014/5730	5meter	70Lm/w	160°	≥30,000hrs
YZS-ST-DC-IP65	2700-7500K	5w/m	AC 220V	2835	5meter	70Lm/w	160°	≥30,000hrs
YZS-ST-DC-RGB	RGB	5w/m	AC 220V	5050	5meter	70Lm/w	160°	≥30,000hrs
YZS-ST-DC-PK		5w/m	AC 220V		5meter	70Lm/w	160°	≥30,000hrs



## 应用场景 Case scenario





Model No	Dimension	Power	Voltage	Light Source	CCT	Flux	Beam Angle	Life Span
YZS-PND-TR-3W	Φ85mm	3W	AC85V-260V	SMD4014/2835	2700-7500K	80Lm/w	120°	≥30,000hrs
YZS-PND-TR-6W	Φ120mm	6W	AC85V-260V	SMD4014/2835	2700-7500K	80Lm/w	120°	≥30,000hrs
YZS-PND-TR-12W	Φ170mm	12W	AC85V-260V	SMD4014/2835	2700-7500K	80Lm/w	120°	≥30,000hrs
YZS-PND-TR-24W	Φ300mm	24W	AC85V-260V	SMD4014/2835	2700-7500K	80Lm/w	120°	≥30,000hrs

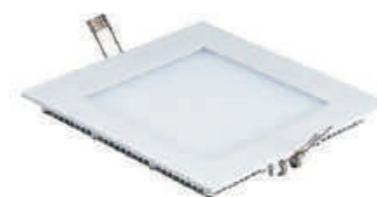

Model No	Dimension	Power	Voltage	Light Source	CCT	Flux	Beam Angle	Life Span
YZS-PND-TQ-3W	85x85mm	3W	AC85V-260V	SMD4014/2835	2700-7500K	80Lm/w	120°	≥30,000hrs
YZS-PND-TQ-6W	120x120mm	6W	AC85V-260V	SMD4014/2835	2700-7500K	80Lm/w	120°	≥30,000hrs
YZS-PND-TQ-12W	170x170mm	12W	AC85V-260V	SMD4014/2835	2700-7500K	80Lm/w	120°	≥30,000hrs
YZS-PND-TQ-24W	300x300mm	24W	AC85V-260V	SMD4014/2835	2700-7500K	80Lm/w	120°	≥30,000hrs



Model No	Dimension	Power	Voltage	Light Source	CCT	Flux	Beam Angle	Life Span
YZS-PND-TQ-6W	120x120mm	6W	AC85V-260V	SMD4014/2835	2700-7500K	80Lm/w	120°	≥30,000hrs
YZS-PND-TQ-12W	170x170mm	12W	AC85V-260V	SMD4014/2835	2700-7500K	80Lm/w	120°	≥30,000hrs
YZS-PND-TQ-18W	225x225mm	18W	AC85V-260V	SMD4014/2835	2700-7500K	80Lm/w	120°	≥30,000hrs
YZS-PND-TQ-24W	300x300mm	24W	AC85V-260V	SMD4014/2835	2700-7500K	80Lm/w	120°	≥30,000hrs

## EASY INSTALLATION

1. Screw the holder on ceiling

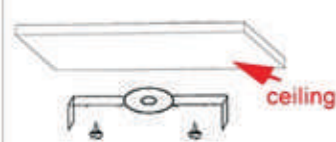

2. Connect AC 220V driver

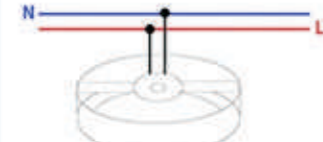

3. Hold the lamp body and tighten screws

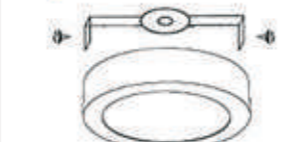

4. Turn on the lamp checking whether it is functioning well

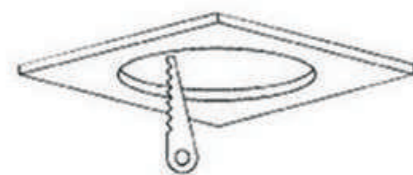
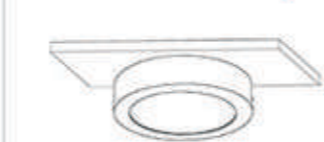

1. 按灯具的开孔尺寸开孔



3. 将灯具装入天花板

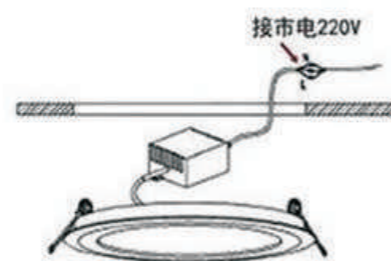

2. 断电后, 连接灯具电线

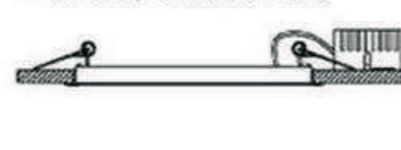

4. 安装完成



# LED 面板灯&平板灯

适用于办公照明, 写字楼照明, 商业照明, 厨卫间照明, 酒店照明

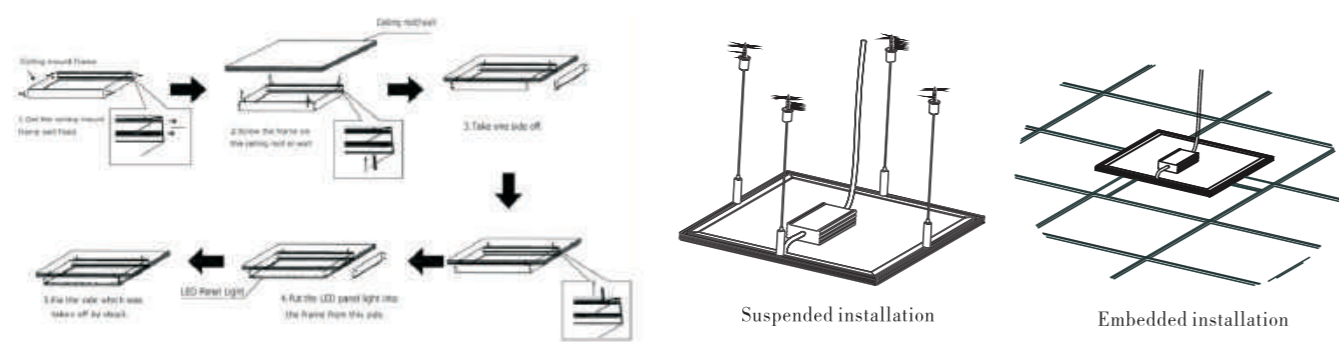

## Driver

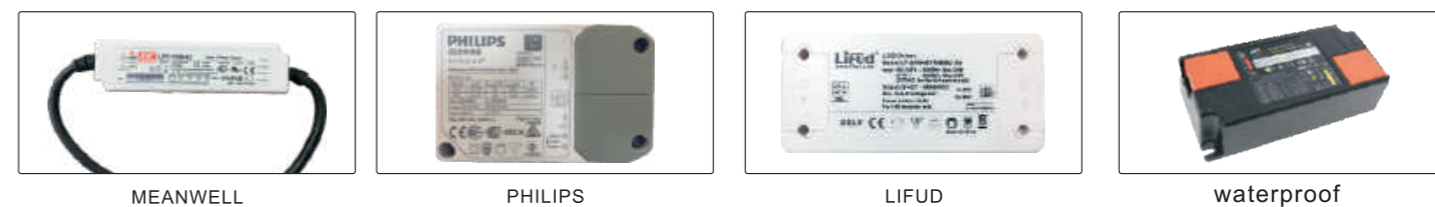

Model No	Dimension	Power	Voltage	Light Source	CCT	Flux	Beam Angle	Life Span
YZS-PN3030	L295xW295xH9mm	12w	AC220V	SMD2835	3000-6500K	1080Lm	120°	≥50,000hrs
YZS-PN6030	L595xW295xH9mm	24w	AC220V	SMD2835	3000-6500K	2160Lm	120°	≥50,000hrs
YZS-PN12030	L1195xW295xH9mm	36w	AC220V	SMD2835	3000-6500K	3240Lm	120°	≥50,000hrs
YZS-PN6060	L595xW595xH9mm	36w	AC220V	SMD2835	3000-6500K	3240Lm	120°	≥50,000hrs
YZS-PN12060	L1195xW595xH9mm	72w	AC220V	SMD2835	3000-6500K	6480Lm	120°	≥50,000hrs

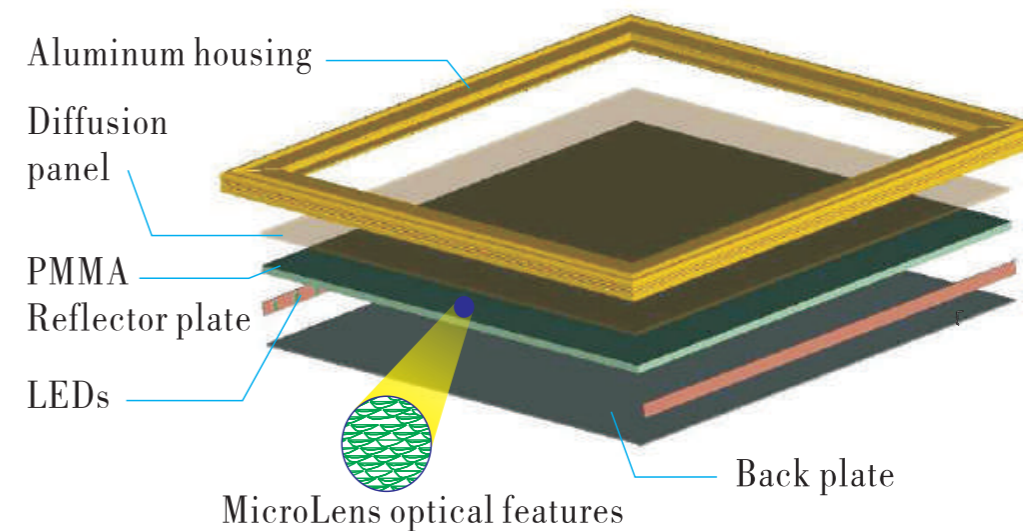





## 灯管安装步骤

### 1 LED单灯管接线示意图

PS: 先关掉电源再根据步骤安装; 电压必须为220V 常用电压

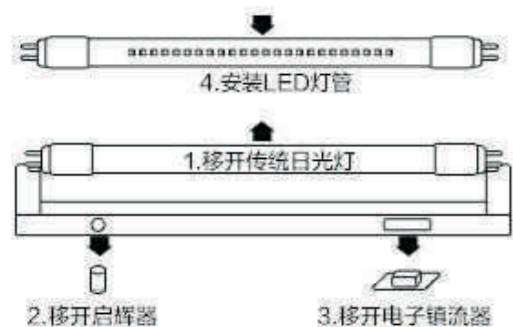

### 2 LED一体化灯管接线示意图



安装的时候必须确保灯体安装稳固!

### 3 LED一体化灯管串联示意图

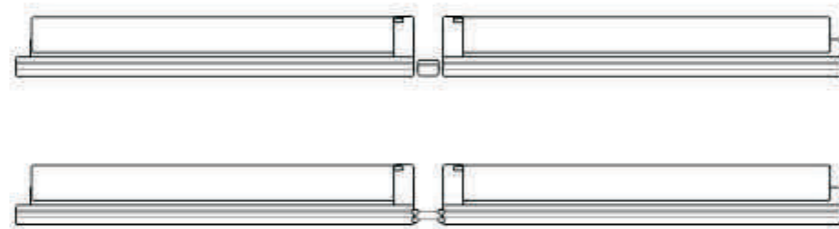

注意: 18W灯管串联严禁超过3根, 9W严禁超过5根, 由此造成的损毁, 本店概不负责

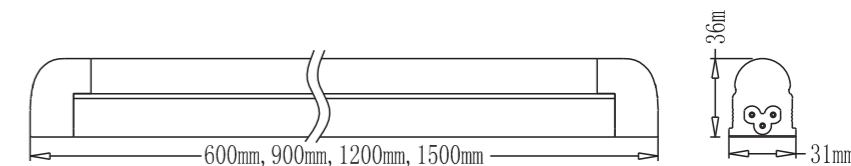

Model No	Dimension	Power	Voltage	Light Source	CCT	Flux	Beam Angle	Life Span
YZS-T806-U	L600xW31xH36mm	12W	AC85V-260V	SMD3014/5730	2700-7500K	920Lm	160°	≥30,000hrs
YZS-T809-U	L900xW31xH36mm	16W	AC85V-260V	SMD3014/5730	2700-7500K	1240Lm	160°	≥30,000hrs
YZS-T812-U	L1200xW31xH36mm	20W	AC85V-260V	SMD3014/5730	2700-7500K	1840Lm	160°	≥30,000hrs
YZS-T815-U	L1500xW31xH36mm	24W	AC85V-260V	SMD3014/5730	2700-7500K	2300Lm	160°	≥30,000hrs

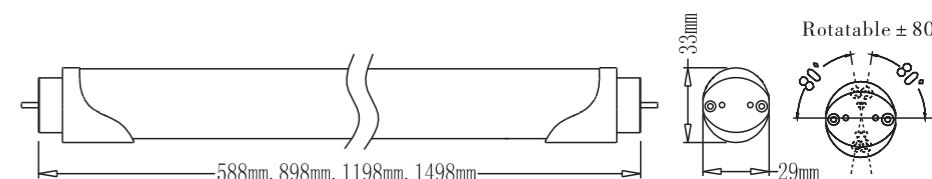

Model No	Dimension	Power	Voltage	Light Source	CCT	Flux	Beam Angle	Life Span
YZS-T806-A	L588xW29xH33mm	12W	AC85V-260V	SMD3014/5730	2700-7500K	1070Lm	160°	≥30,000hrs
YZS-T809-A	L898xW29xH33mm	16W	AC85V-260V	SMD3014/5730	2700-7500K	1540Lm	160°	≥30,000hrs
YZS-T812-A	L1198xW29xH33mm	20W	AC85V-260V	SMD3014/5730	2700-7500K	2000Lm	160°	≥30,000hrs
YZS-T815-A	L1498xW29xH33mm	24W	AC85V-260V	SMD3014/5730	2700-7500K	2550Lm	160°	≥30,000hrs

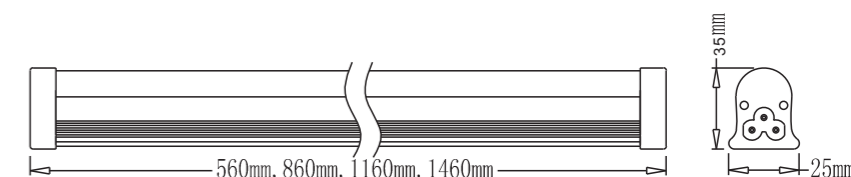

Model No	Dimension	Power	Voltage	Light Source	CCT	Flux	Beam Angle	Life Span
YZS-T506-U	L560xW25x35mm	11W	AC85V-260V	SMD3014	2700-7500K	910Lm	160°	≥30,000hrs
YZS-T509-U	L860xW25x35mm	15W	AC85V-260V	SMD3014	2700-7500K	1420Lm	160°	≥30,000hrs
YZS-T512-U	L1160xW25x35mm	18W	AC85V-260V	SMD3014	2700-7500K	1820Lm	160°	≥30,000hrs
YZS-T515-U	L1460xW25x35mm	24W	AC85V-260V	SMD3014	2700-7500K	2500Lm	160°	≥30,000hrs

### YZS-BU-A60



small size

9W

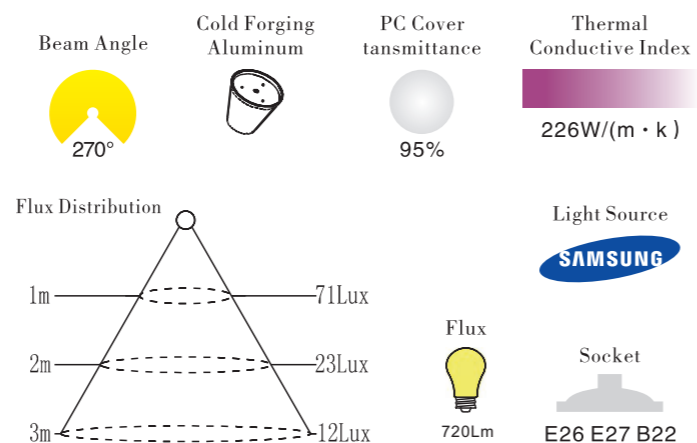
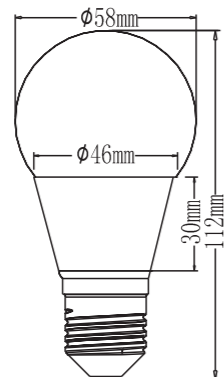

### YZS-BU-H18



High Bulb

18W

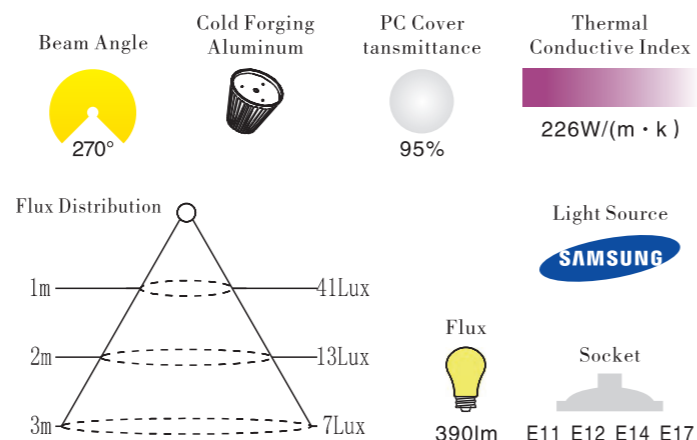
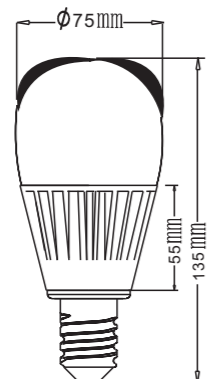

Model No	Power	Voltage	Light Source	CCT	Flux	Dimension	Socket	Beam Angle	Life Span
YZS-BU-A50	3-5W	Ac220v	SMD5630	2700-7500K	80Lm/w	φ50xH90mm	E26 E27 B22	180°	≥30,000hrs
YZS-BU-A60	7-9W	Ac220v	SMD5630	2700-7500K	80Lm/w	φ60xH105mm	E26 E27 B22	180°	≥30,000hrs
YZS-BU-A70	12-15W	Ac220v	SMD5630	2700-7500K	80Lm/w	φ70xH115mm	E26 E27 B22	180°	≥30,000hrs
YZS-BU-H80	18W	Ac220v	SMD5630	2700-7500K	80Lm/w	φ80xH135mm	E26 E27 B22	180°	≥30,000hrs
YZS-BU-H100	28W	Ac220v	SMD5630	2700-7500K	80Lm/w		E26 E27 B22	180°	≥30,000hrs
YZS-BU-H115	38W	Ac220v	SMD5630	2700-7500K	80Lm/w		E26 E27 B22	180°	≥30,000hrs
YZS-BU-H120	48W	Ac220v	SMD5630	2700-7500K	80Lm/w		E26 E27 B22	180°	≥30,000hrs

### YZS-BU-GU10



mini size

COB 6W

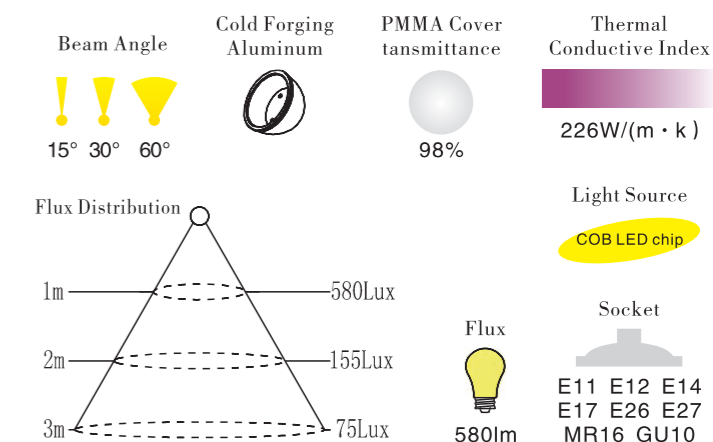



Dimension(mm)

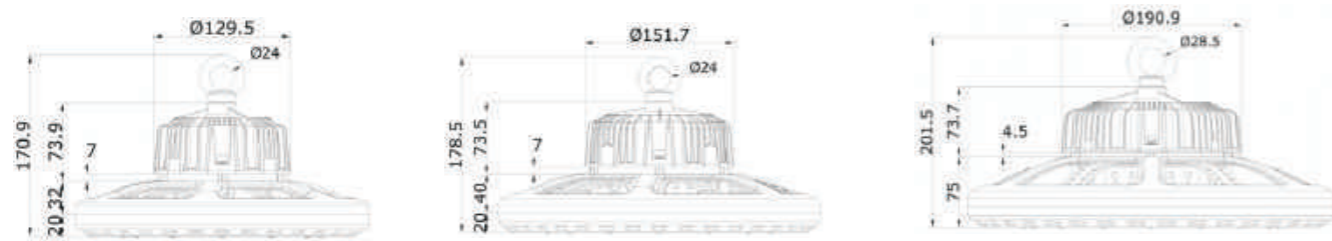

Installation



规格参数/ Specification List

Model	YZS-UFO4-100W	YZS-UFO4-150W	YZS-UFO4-200W
Materials	Aluminum Alloy	Aluminum Alloy	Aluminum Alloy
Power	100W	150W	200W
Luminous Efficiency	120-140LM/W	120-140LM/W	120-140LM/W
Luminous Flux	12000LM	18000LM	24000LM
Input Voltage	AC85~265V	Ac85~265V	A85~265V
LED Qty	119pcs 3030 Osram	196pcs 3030 Osram	252pcs 3030 Osram
Power Factor	> 0.95	> 0.95	> 0.95
CCT	2700-6500K	2700-6500K	2700-6500K
CRI	> 80	> 80	> 80
Working Temperature	-35°C ~ 55°C	-35°C ~ 55°C	-35°C ~ 55°C
Power Supply	Mean Well	Mean Well	Mean Well
IP Grade	IP65	IP65	IP65
Beam Angle	60°/90°/120°	60°/90°/120°	60°/90°/120°
Life Span	50000H	50000H	50000H
Dimension	278×278×170.9mm	328×328×178.5mm	388×388×201.5mm
Certification	ETL、DLC、TUV	ETL、DLC、TUV	ETL、DLC、TUV

Light distribution curve

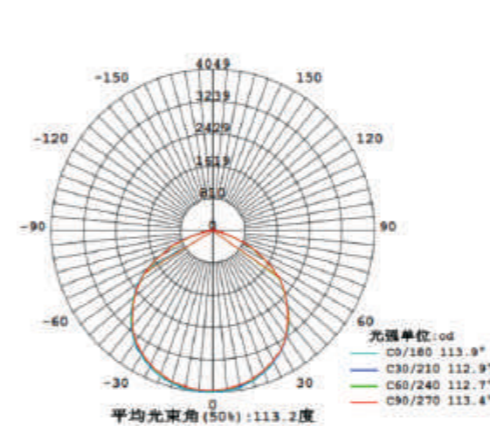

Cone Lux Diagram

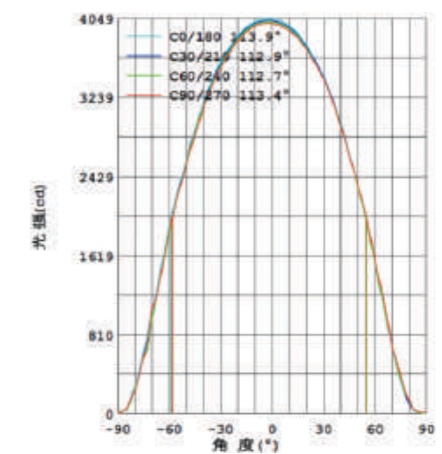



### 【产品特点 Feature】

- \* 高PF, 高效率
- \* 隔离驱动电源
- \* 宽压AC85-265V
- \* 采用安全可靠恒流模式
- \* 开路、短路、过载、过压保护。
- \* No strobe
- \* Isolated drive power
- \* input : AC85-265V
- \* Adopt safe and reliable constant current mode
- \* Open circuit, short circuit, overload, over voltage protection

Model No	Dimension	Power	Input	PFC	Output	Current	Shell	Life Span
YZS-DR-IP65-20W	115x40x30mm	20W	AC85V-260V	0.95	DC 24-45V	600mA	Al alloy	≥30,000hrs
YZS-DR-IP65-30W	115x40x30mm	30W	AC85V-260V	0.95	DC 24-45V	900mA	Al alloy	≥30,000hrs
YZS-DR-IP65-40W	115x40x30mm	40W	AC85V-260V	0.95	DC 24-45V	1200mA	Al alloy	≥30,000hrs
YZS-DR-IP65-50W	140x42x32mm	50W	AC85V-260V	0.95	DC 24-45V	1500mA	Al alloy	≥30,000hrs
YZS-DR-IP65-80W	180x61x38mm	80W	AC85V-260V	0.95	DC 24-45V	1500mA	Al alloy	≥30,000hrs
YZS-DR-IP65-100W	180x61x38mm	100W	AC85V-260V	0.95	DC 24-45V	1500mA	Al alloy	≥30,000hrs
YZS-DR-IP65-150W	210*68*39mm	150W	AC85V-260V	0.95	DC 24-45V	1500mA	Al alloy	≥30,000hrs



### 【产品特点 Feature】

- \* 无频闪
- \* 隔离驱动电源
- \* 宽压AC85-265V
- \* 采用安全可靠恒流模式
- \* 开路、短路、过载、过压保护。
- \* No strobe
- \* Isolated drive power
- \* input : AC85-265V
- \* Adopt safe and reliable constant current mode
- \* Open circuit, short circuit, overload, over voltage protection

Model No	Dimension	Power	Input	PFC	Output	Current	Shell	Life Span
YZS-DR-IP40-1/3W	80x32x23mm	3W	AC85V-260V	0.65	DC 9-12V	300mA	Plastic	≥30,000hrs
YZS-DR-IP40-5/8W	80x32x23mm	8W	AC85V-260V	0.65	DC 12-24V	300mA	Plastic	≥30,000hrs
YZS-DR-IP40-8/12W	80x32x23mm	12W	AC85V-260V	0.65	DC 24-45V	300mA	Plastic	≥30,000hrs
YZS-DR-IP40-18W	115x45x25mm	18W	AC85V-260V	0.65	DC 45-60V	300mA	Plastic	≥30,000hrs
YZS-DR-IP40-24W	115x45x25mm	24W	AC85V-260V	0.65	DC 60-75V	300mA	Plastic	≥30,000hrs
YZS-DR-IP40-36W	115x45x25mm	36W	AC85V-260V	0.65	DC 36-45V	950mA	Plastic	≥30,000hrs
YZS-DR-IP40-42W	115x45x25mm	40W	AC85V-260V	0.65	DC 36-45V	1250mA	Plastic	≥30,000hrs

产品规格参数 Product specifications

产品名称 Product name	WiFi控制器 WiFi controller
输入电压 Input voltage	DC5-24V
输出电流 Output current	5X6A
最大功率 Maximum power	360瓦
最大输出电流 Maximum output current	30A
输出端口 Outout port	RGB/RGB+W/RGB+WW/RGB+CCT
控制模式 Control mode	手机APP
内置指示灯 Built-in indicator light	RGB+白光+暖光
网络协议 Network protocol	双协议, 终端同步 Dual protocol, terminal synchronization
断电记忆 Power off memory	支持 support
按键切换 Key switch	支持 support
自动配网 Automatic distribution network	支持 support
产品尺寸 Product Size	115x68x26mm
产品重量 product weight	180G
网络通信 Telecommunication	WIFI或4G网络 WIFI or 4G network
应用产品 Application products	灯带, 线条灯, 面板灯, 筒灯 Light strip, line light, panel light, down light
兼容设备 Compatible device	天猫精灵, 小米, 百度小爱, 叮咚 Amazon, Alexa, Google, assistant
支持定制 Support customization	WiFi, ZigBee, 2.4G、红外、高压输入输出, 功率定制, 硬件定制 WiFi, ZigBee, 2.4G, infrared, high voltage input and output

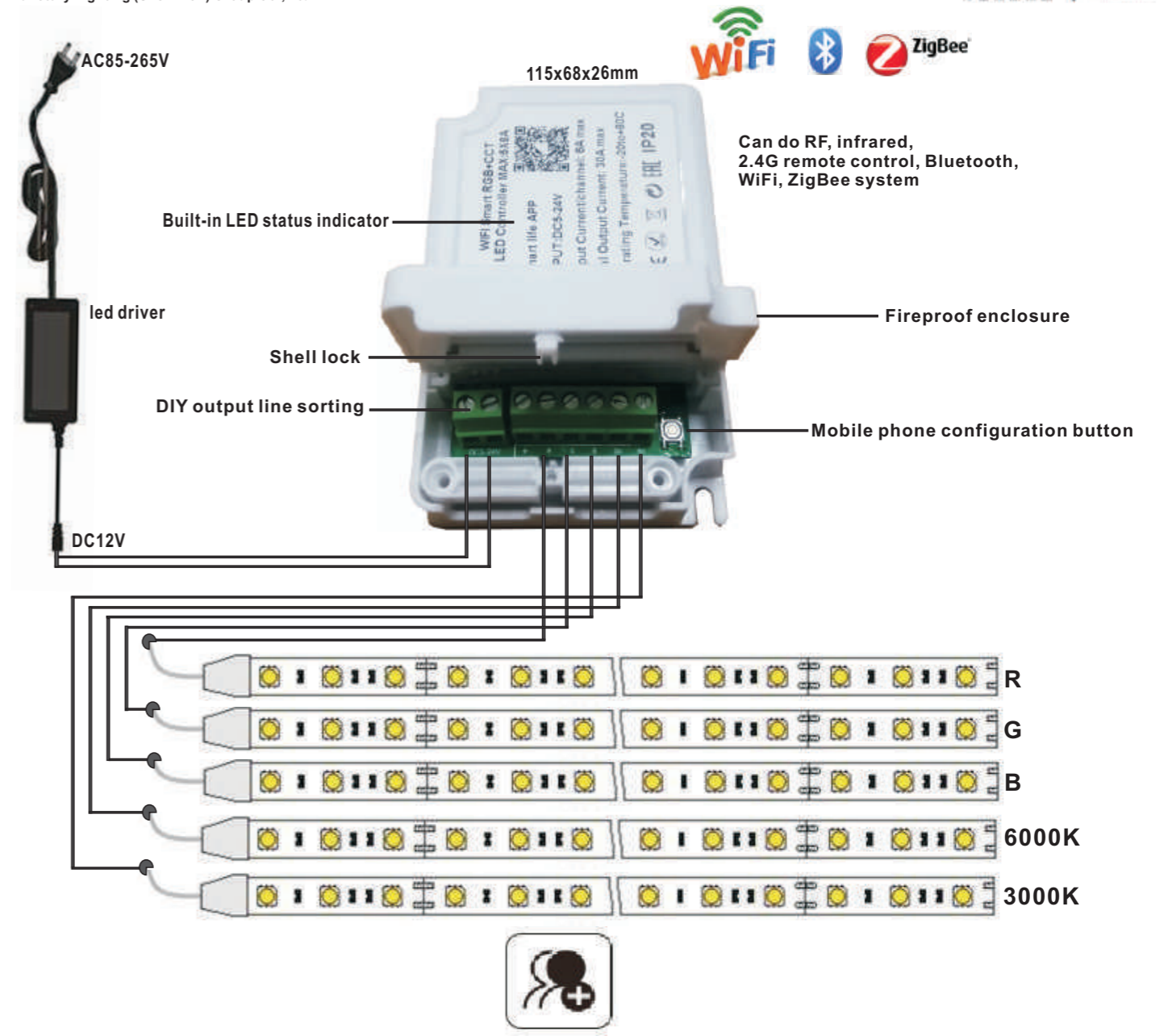

**Grouping Settings, Grouping control**

One mobile phone control, unlimited control terminal, controller multiple lights in parallel

Multiple phones sharing device



## 产品参数 Product parameter

输入电压 Input voltage	DC5-24V
最大功率 Maximum power	120W
工作频率 working frequency	2.4G
网络通讯 Network communication	WIFI & 4G
输出端口 Output port	RGB / RGB+W / RGB+WW / RGB+CCT
控制模式 Control mode	手机APP
控制功能 control function	调光, 调色, RGB, 自定义场景闪烁, 音乐炫动, 定时 Dimming, color toning, RGB, custom scene flashing, music dazzling, timing
产品尺寸 Product Size	含线长290mm, 壳宽24mm, 壳高12mm Including cable length 290mm, shell width 24mm, shell height 12mm
单个包装尺寸 Single package size	静电袋120*80*12mm
配网方式 Distribution network	长按3秒按键, LED快闪 (可定制无须开关配网) Long press the button for 3 seconds, the LED flashes quickly (can be customized without switching the network)
产品单重量 product single weight	50G
产品应用 Applications	灯带 (可定制适用于面板灯, 工矿灯, 轨道灯, 筒灯) Light strip (can be customized for panel lights, high bay lights, track lights, down lights)
兼容设备 Compatible device	国内: 天猫精灵, 小米, 百度小爱, 叮咚 Amazon, Alexa, Google, Assistant
支持定制 Support customization	功率定制, 控制界面部分定制, 硬件定制, 贴牌打标 Power customization, control interface part customization, hardware customization, OEM

## General ordering instructions for WiFi controllers

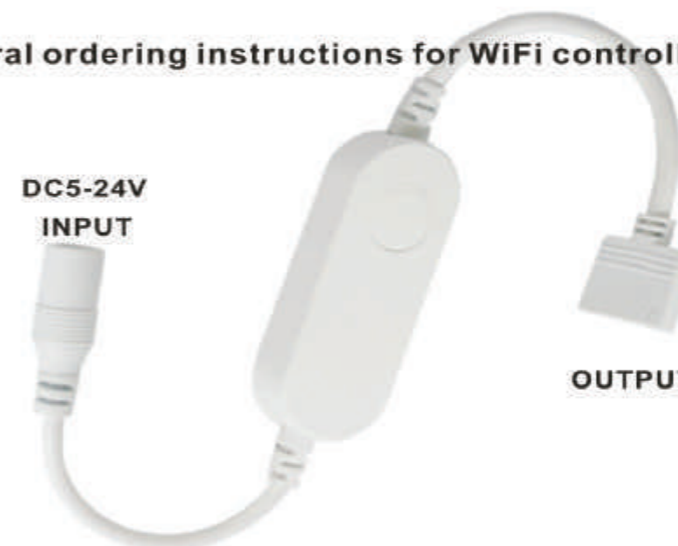

LED light strip controller

Global networking,  
support customization,  
OEM

Can do RF, infrared,  
2.4G remote control, Bluetooth,  
WiFi, ZigBee system

### Normal output sorting

+ W WW Name: CCT

+ R G B Name: RGB

+ R G B W Name: RGBW

+ R G B WW Name: RGBWW

+ WW R G B W Name: RGB+CCT

Before production, please confirm whether the order of the light strips is the same, and you can change the order. Some light strips on the market are wrong, please power on to confirm



## LED Linear Drive - Ultra-thin Flood Light



### 规格参数/Specification List

型号/Model	尺寸/Size	功率/Power	流明/Lumen	色温/CCT	发光角度	输入/Input	电源/Driver	防水/IP
YZS-FLUL-10W	105*35*85mm	10W	85Lm/W	2700-6000K	90°	AC220-240V	线性驱动	Ip65
YZS-FLUL-20W	153*25*110mm	20W	85Lm/W	2700-6000K	90°	AC220-240V	线性驱动	Ip65
YZS-FLUL-30W	205*30*160mm	30W	85Lm/W	2700-6000K	90°	AC220-240V	线性驱动	Ip65
YZS-FLUL-50W	240*30*170mm	50W	85Lm/W	2700-6000K	90°	AC220-240V	线性驱动	Ip65
YZS-FLUL-70W	305*30*205mm	70W	85Lm/W	2700-6000K	90°	AC220-240V	线性驱动	Ip65
YZS-FLUL-100W	333*40*254mm	100W	85Lm/W	2700-6000K	90°	AC220-240V	线性驱动	Ip65
YZS-FLUL-150W	365*42*280mm	150W	85Lm/W	2700-6000K	90°	AC220-240V	线性驱动	Ip65

线性驱动：驱动电源部分集成在铝基板里面，成本低重量轻，运输方便



### 规格参数/Specification List

型号/Model	尺寸/Size	功率/Power	流明/Lumen	色温/CCT	发光角度	输入/Input	电源/Driver	防水/IP
YZS-F1-10W	130*120*40mm	10W	85Lm/W	2700-6000K	120°	AC85-265V	CE/ROHS	Ip65
YZS-F1-20W	180*160*40mm	20W	120/140Lm/W	2700-6000K	120°	AC85-265V	CE/ROHS	Ip65
YZS-F1-30W	230*200*50mm	30W	120/140Lm/W	2700-6000K	120°	AC85-265V	CE/ROHS	Ip65
YZS-F1-50W	290*240*60mm	50W	120/140Lm/W	2700-6000K	120°	AC85-265V	CE/ROHS	Ip65
YZS-F1-100W	350*300*80mm	100W	120/140Lm/W	2700-6000K	120°	AC85-265V	CE/ROHS	Ip65